

**BANG & OLUFSEN**

**BEOSYSTEM 3500**

CAUTION: Use of any controls, adjustments or procedures other than those specified herein may result in hazardous radiation exposure.

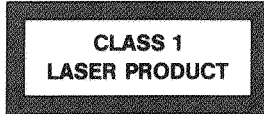

The black and yellow label on the compact disc player serves as a warning that the apparatus contains a laser system and is classified as a class 1 laser product. In case of any trouble with the compact disc player, please contact your Bang & Olufsen dealer. The apparatus must be opened by qualified servicemen only.



# Beosystem 3500

---

*The Beosystem 3500 consists of:*

- the **Beomaster 3500**, an AM/FM tuner/amplifier with 20 presets. It is a stereo radio which automatically reproduces stereo sound if tuned to an FM station transmitting in stereo.
- the **Beocord 3500**, a tape recorder equipped with the HX Pro system, developed by Bang & Olufsen, to ensure optimum recording quality.
- the **Beogram CD 3500**, a compact disc player with outstanding sound reproduction quality. It is equipped with a special disc clamber allowing it to be hung vertically on a wall.
- the **Beogram 3500**, a record player equipped with a RIAA pre-amplifier, meaning that if it is to be connected to a tuner/amplifier other than the Beomaster 3500, it must be connected to a Tape or Aux socket, i.e. a socket intended for a LINE signal.

 HX - PRO

 COMPACT  
disc  
DIGITAL AUDIO

## How to use this manual

---

This manual explains how to set up and how to operate each unit of the Beosystem 3500.

The lay-out of the manual ensures that you can easily find your way through it. The section "Setting up" explains how to make the units of the Beosystem 3500 ready for use. For operation of the Beomaster 3500, the Beocord 3500, the Beogram CD 3500 or the Beogram 3500, see the appropriate section. If you look for a specific function, the detailed table of contents may serve as your guide.

The instructions in the manual refer to the sensi-touch fields of the appropriate unit which are indicated by small boxes with the appropriate text or symbol inside them.

# Table of contents

---

## 6 SETTING UP

- Making the Beograms ready for play, 6
- Where to place the Beosystem 3500, 7
- Connections, 8
- Stand-by mode, 9

## 10 THE BEOMASTER 3500

- The operation panel, 10
- Switching on, 11
- Switching off, 12
- Muting, 12
- Automatic stand-by, 12
- Tuning and presetting radio stations, 13
  - Automatic tuning / Tuning by keying in the frequency / Manual tuning
- FM and AM frequency ranges, 15
- Sound adjustments, 16
  - Volume / Balance / Bass / Treble / Loudness
- Sockets on the rear panel, 18

## 22 THE BEOCORD 3500

- Loading a cassette, 22
- Playing back a tape, 22
- Winding and rewinding, 23
- Stepping through tracks, 23
- Recording, 24
- Using the auto reverse function, 24
- Using Dolby NR\*, 25
- Recording level, 25

## 26 THE BEOGRAM CD 3500

- Loading a compact disc, 26
- Playing a compact disc, 26
- Searching through a compact disc, 27
- Stepping through tracks, 27
- Digital output, 27

## 28 THE BEOGRAM 3500

- Adjusting stylus pressure, 28
- Setting speed, 29
- Playing a record, 29
- Pausing, 30
- Stepping through a record, 30
- Repeating a record, 31

- 32 REMOTE CONTROL
- 34 THE BEOMASTER 3500 IN A BEOLINK SYSTEM
  - How to obtain the Beolink functions, 35
- 36 OPTIONAL ACCESSORIES
  - Wall bracket, 36    ○ Headphones, 36    Indoor antennae, 37
  - Beolink cable, 37    ○ Master Control Link 2, 37
- 38 MAINTENANCE
  - Surfaces, 38    ○ Tape deck, 38    ○ Stylus, 39
- 40 TECHNICAL SPECIFICATIONS
- 43 INTERNATIONAL GUARANTEE

\* Trademark of Dolby Laboratories Licensing Corporation.  
Noise reduction system manufactured under License from Dolby Laboratories Licensing Corporation.

## SETTING UP

### Making the Beograms ready for play

#### Beogram CD 3500

If the CD-player has been exposed to low temperatures during transport and is then placed in a warm room, condensation can form within the mechanism. If this happens, the CD-player cannot function until the humidity has dropped to an acceptable level. Therefore, allow it to adjust to room temperature for at least an hour or two before use.

The CD-player is provided with screws on the base to protect the suspension during transport. These screws must be removed before you can operate the CD-player. Tilt the CD-player to an upright position while holding it firmly. Remove the two red screws and place them in the storage holes.

#### Beogram 3500

The record player is provided with screws on the base to protect the suspension during transport. These screws must be loosened before you can operate the record player. Place the record player on a table

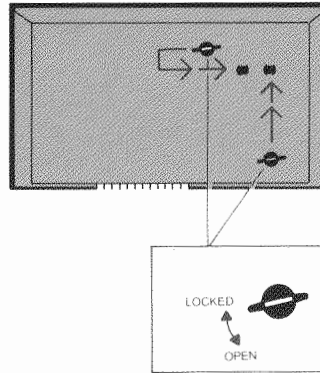

so that the front protrudes over the edge. Hold the record player firmly and turn it carefully to locate and loosen each of the three screws. Turn the screws anti-clockwise (several turns) using a screwdriver or a coin. The screws cannot be removed from the holes.

Remove the foam rubber pieces protecting the tonearm. Be careful not to catch the stylus. Place the platter on the turntable and check that it can move freely. It should

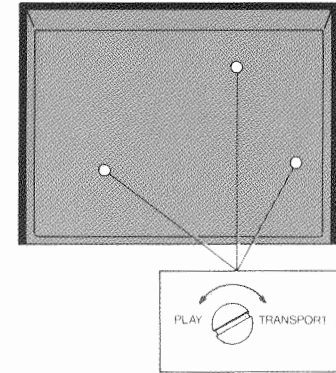

feel springy when pressed lightly. Don't forget to raise the stylus guard on the cartridge.

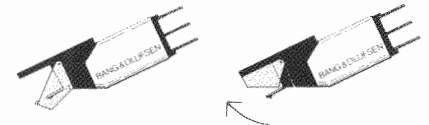



If you ever have to transport the Beograms, we strongly recommend you tighten the transport screws before doing so.

## Where to place the Beosystem 3500

All the units of the Beosystem 3500 must be placed so that ventilation cannot be impeded. Avoid placing them in direct sunlight, near radiators or other sources of heat.

Leave a space of at least 15 cm above the tape recorder and CD-player and at least 25 cm above the record player to allow the dust covers to open freely.

The plastic feet supplied with the Beomaster 3500, the Beocord 3500 and the Beogram CD 3500 enable you to place the products in a slightly tilted position on a stable surface. Insert the feet in the holes provided on the base. The *Beogram 3500*, however, *must* be placed horizontally.

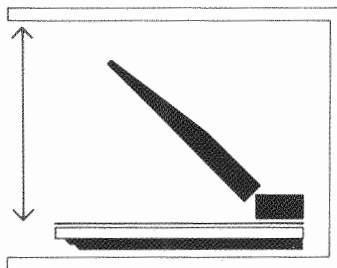

Alternatively, the Beosystem 3500 can be hung on a wall. For this purpose, the WB 4500 wall bracket is available as an optional accessory; please see "Optional accessories".

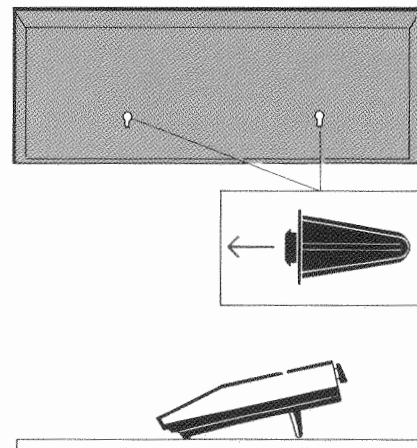



The metal bars supplied with the Beomaster 3500, the Beocord 3500 and the Beogram CD 3500 are for concealing cables. When you have made the necessary connections, insert the bars in the holes provided on the rear panels and press downwards.

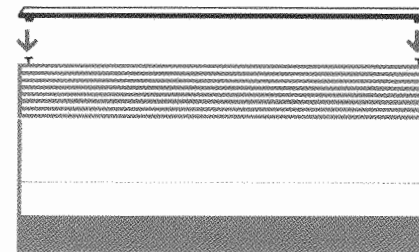

## Stand-by mode

---

Once connected to the mains, each unit in the Beosystem 3500 is in so-called stand-by mode and ready to be operated. Stand-by mode is indicated by a tiny red light on the right-hand side of the operation panel. The Beosystem 3500 is designed to be left in stand-by mode when not in use.

## THE BEOMASTER 3500

*This section explains how to operate the Beomaster 3500. Before you start using the tuner/amplifier, make sure you have made all the*

*necessary connections. For details about making your Beomaster 3500 ready for use, please refer to the section "Setting up".*

### The operation panel



The controls identified by grey print on the operation panel give you access to the primary functions. You will find that other controls appear in green colour when you have pressed some of the primary controls. They will light up for a limited period of time, so if they disappear before you have finished your instructions, you simply start again.

When you operate the Beomaster, cues in red colour appear above the primary controls. They indicate source and sound adjustments and whether you are on the FM or AM band.

A 4-digit display, also located in the upper part of the operation panel, will give you information on preset numbers, frequencies, sound levels and options.

# Switching on

---

Switch on by selecting any of the sources available in your Beosystem 3500. Touch the appropriate text:

**CD** Turns on the Beogram CD 3500 compact disc player. If you press **PLAY** on the Beogram CD 3500 to start playing a compact disc, the Beomaster switches on automatically.

**PHONO** Turns on the Beogram 3500 record player. If you press **PLAY** on the Beogram 3500 to start playing a record, the Beomaster switches on automatically.

**TAPE 2** Turns on any second Bang & Olufsen tape recorder equipped with Datalink. If you press **PLAY** on the Beocord to start playing a tape, the Beomaster 3500 switches on automatically.

**TAPE 1** Turns on the Beocord 3500 tape recorder. If you press **PLAY** on the Beocord 3500 to start playback, the Beomaster switches on automatically.

**AUX** Selects the AUX/TV socket as source. For further details, see "Sockets on the rear panel".

**0 - 9** Turns on the radio station preset on the appropriate number (max. 20). No station can be preset on number 0.

**0** Turns on the radio station you were last listening to.

**MUTE** Turns on the source in your Beosystem 3500 you were last listening to.

Whenever you switch on, the source selected will start playing at the preset sound level stored in the Beomaster. The source selected will be indicated on the operation panel of the Beomaster 3500.

## Switching off



---

Switch off by pressing  on the right-hand side of the operation panel. The Beomaster will revert to stand-by mode. The other units in the Beosystem 3500, if any, will also revert to stand-by mode.



## Muting

---

Press  to make the sound disappear immediately. This is useful if you want temporary silence without switching off. Press  again to recall the sound.

The mute function only applies to the loudspeakers connected to the upper pair of speaker sockets or to the POWER LINK sockets.

MUTE

## Automatic stand-by

---

Within 30 minutes of finishing a record, a tape or a compact disc, the Beosystem 3500 automatically returns to stand-by.



## Tuning and presetting radio stations

The radio must be tuned to pick up the stations available in your area. You can preset a total of 20 stations.

The tuning of radio stations can be carried out in three different ways:

- Automatic tuning
- Tuning by keying in the frequency
- Manual tuning

### ○ Automatic tuning

The automatic tuning function is useful if you are not familiar with the radio stations and their frequencies.

1. Switch on by pressing any of the numbers **0** - **9**.  
The chosen number is displayed.
2. Press **PROGRAMMING**.  
The display indicates the current frequency, and the controls GOTO and STORE become accessible.
3. Press **GO TO**.  
The display indicates ----, and the controls AM/FM, < and > become accessible.
4. Press **AM/FM** if you want to switch from AM to FM or vice versa.
5. Press **>** to search upwards or **<** to search downwards through the frequencies.  
The Beomaster will stop at the first station producing an acceptable signal.  
If this is not the station you want, press **>** or **<** again.

6. Press **STORE** to preset the station found.

The first vacant preset number flashes.

7. If you do not want to use this number, key in the number of your choice (no station can be preset on number 0).
8. Press **STORE** another time to preset the station.

### ○ Tuning by keying in the frequency

If you know the exact frequency of the station you want, you can key it in directly:

1. Switch on by pressing any of the numbers [0] - [9].  
The chosen number is displayed.
2. Press [PROGRAMMING].  
The display indicates the current frequency, and the controls GOTO and STORE become accessible.
3. Press [GO TO].  
The display indicates ----, and the controls AM/FM, < and > become accessible.
4. Press [AM/FM] if you want to switch from AM to FM or vice versa.
5. Key in the appropriate frequency using three or four digits, as required.
6. Press [STORE] to preset the station found.  
The first vacant preset number flashes.
7. If you do not want to use this number, key in the number of your choice (no station can be preset on number 0).

8. Press [STORE] another time to preset the station.

### ○ Manual tuning

The manual tuning function is useful if you want to search slowly through the frequencies, or if you want to detune a station slightly due to noisy reception.

1. Switch on by pressing any of the numbers [0] - [9].  
The chosen number is displayed.
2. Press [PROGRAMMING].  
The display indicates the current frequency, and the controls GOTO and STORE become accessible.
3. Press [GO TO].  
The display indicates ----, and the controls AM/FM, < and > become accessible.
4. Press [AM/FM] if you want to switch from AM to FM or vice versa.
5. Press [GO TO] another time.  
The display indicates the current frequency, and the controls AM/FM and STORE disappear.

6. Keep your finger on [>] to search slowly upwards or on [<] to search slowly downwards through the frequencies until you have found the station you want. The longer you keep your finger on [>] or [<], the higher the search speed.
7. Press [STORE] to preset the station found.  
The first vacant preset number flashes.
8. If you do not want to use this number, key in the number of your choice (no station can be preset on number 0).
9. Press [STORE] another time to preset the station.



Repeat any of these procedures to tune in and preset other stations.

If you tune in a frequency (station) which you have already preset, this preset number will appear in the display rather than the first vacant preset number. This serves

as a reminder that you have already preset the station.

If you select a number to which a station has not been assigned, the tuner will move to the start of the FM band (87.5 MHz).

## FM and AM frequency ranges

---

The frequencies in the FM band range from 87.5 MHz to 108.0 MHz.

The frequencies in the AM band range from 150 kHz to 1610 kHz.

The AM band covers both LW and MW stations:

- LW stations are between 150 and 350 kHz
- MW stations are between 520 and 1610 kHz

The **AM/FM** control is used to switch between the FM and AM bands. Each time you switch from the FM band to the AM band or vice versa, the tuner will move to the start of the band.

The display indicates AM frequencies in kHz with no decimals. FM frequencies are stated in MHz with one decimal.



FM: 87.5 - 108.0 MHz

AM: 150 - 350 kHz  
520 - 1610 kHz

## Sound adjustments



*The Beomaster 3500 always switches on at specific preset sound levels. These levels are adjustable, and new preset levels may be stored, if required.*

### Volume

Press  to raise the volume level.  
Press  to lower the volume level.

When you adjust the volume, the current volume level will be indicated by a figure in the display: 00 as the lowest and 90 as the loudest.



To store a new start-up volume level do as follows:



1. Press **[SOUND]** once.
2. Adjust the volume to the desired level using  or .
3. Press **[STORE]** to memorize the new level.

*Note!* The Beomaster cannot be preset to start playing at a volume level exceeding 70. If you attempt to preset a start-up level higher than that, the Beomaster will disregard your instructions and start playing at 70 instead.

### Balance

Balance is an indication of the distribution of sound emerging from the two loudspeakers. You may wish to alter the balance to suit your favourite listening position. The balance setting ranges from 0 to 7. The medium setting is indicated by ---- in the display.

1. Press **[SOUND]** twice.
2. While the BAL cue is still visible, press  or  to adjust the balance.

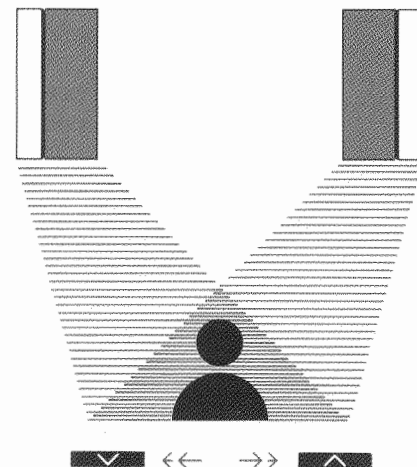

Pressing  shifts the sound to the right loudspeaker, and pressing  shifts the sound to the left loudspeaker.

3. Press **[STORE]** if you want to memorize the new balance.



### Bass

The bass value can be adjusted to suit your personal taste. The bass setting ranges from +6 to -6. The medium setting is indicated by -- in the display.



1. Press **[SOUND]** three times.
2. While the BASS cue is still visible, press  or  to adjust the bass to the desired level.
3. Press **[STORE]** if you want to memorize the new level.

---

Adjusting and presetting volume, balance, bass, treble and loudness may be done in one go by pressing **[SOUND]** only once between each adjustment, and by pressing **[STORE]** only after the last adjustment.



### Treble

The treble value can be adjusted to suit your personal taste. The treble setting ranges from +6 to -6. The medium setting is indicated by -- in the display.

1. Press **[SOUND]** four times.
2. While the TREBLE cue is still visible, press  or  to adjust the treble to the desired level.
3. Press **[STORE]** if you want to memorize the new level.

### Loudness

The loudness function is used to compensate for the human ear's lack of sensitivity to high and low frequencies when you are playing at low volume levels. It 'boosts' the high and low frequencies so that the music becomes more dynamic. You can cut the loudness function in or out as you please.

1. Press **[SOUND]** five times to get access to the loudness function. The LOUDN cue flashes if the function is cut out and glows constantly if it is cut in.
2. Press  to cut in the loudness function, or press  to cut it out.
3. Press **[STORE]** if you want to memorize the new setting.

## Sockets on the rear panel

### AM

Socket for connection of an AM antenna.

### FM

Socket for connection of an FM antenna.

### CD

7-pin DIN socket for connection of the Beogram CD 3500 compact disc player or any other Bang & Olufsen compact disc player.

### TP1

7-pin DIN socket for connection of the Beocord 3500 tape recorder or any other Bang & Olufsen tape recorder.

### AUX/TV

7-pin DIN socket for connection of a Beolink compatible TV-set or for connection of auxiliary equipment without Datalink.

### PH/TP2

7-pin DIN socket for connection of the Beogram 3500 record player, a second tape recorder or CD-player.

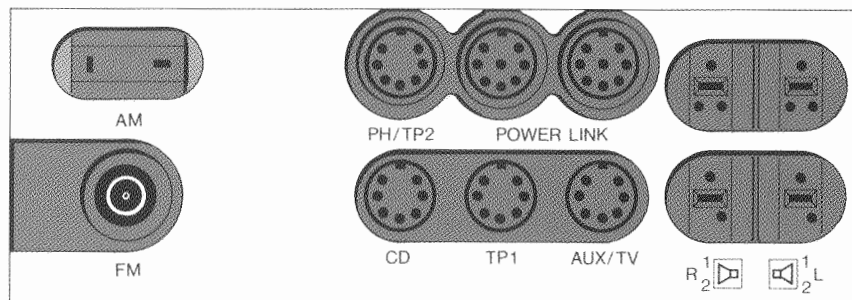

### POWER LINK

8-pin DIN sockets for connection of Bang & Olufsen loudspeakers with Power Link plugs. The Power Link sockets are identical, which means that either socket may be used for left or right loudspeaker. You can also connect just one loudspeaker to a Power Link socket, and then loop the signal to the other using a Power Link cable.

### 1 L/R

4-pin DIN sockets for connection of one set of loudspeakers. L for left channel and R for right channel.

The Beomaster is designed for loudspeakers with an impedance of no less than 8 ohms.

### 2 L/R

3-pin DIN sockets for connection of another set of loudspeakers or a Master Control Link 2 system. L for left channel and R for right channel.

*Note!* If you only want to connect one or more units of the Beosystem 3500 and a TV-set, if any, you need not read the section "Connection possibilities".

### Connection possibilities

The Beomaster 3500 offers connection possibilities for *five* different sources:

**AUX** (e.g. a TV-set), **TAPE 1**, **TAPE 2**, **PHONO** and **CD**.

However, as the Beomaster can only accommodate *four* sources at a time, it may be necessary to 'tell' the Beomaster which products are actually connected. This is done by

changing the option setting of the sockets.

The Beomaster can be set to either of the following options:

- TAPE 2 OP(tion)
- CD OP(tion)
- PHONO OP(tion)

Study the diagrams carefully to identify which option suits your set-up situation.

### TAPE 2 OP

A complete Beosystem 3500 set up as illustrated in the section "Connections". The system has been extended with a Beolink compatible TV-set.

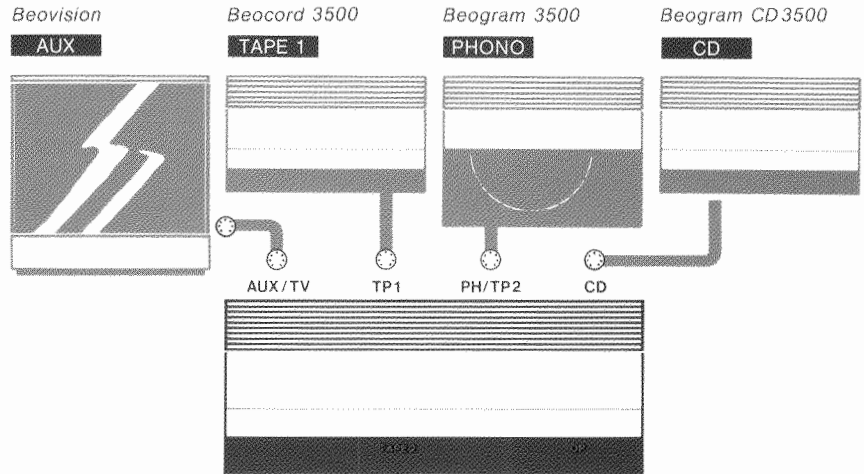

**TAPE 2 OP**

In this set-up a second Beocord has been connected instead of the Beogram 3500.

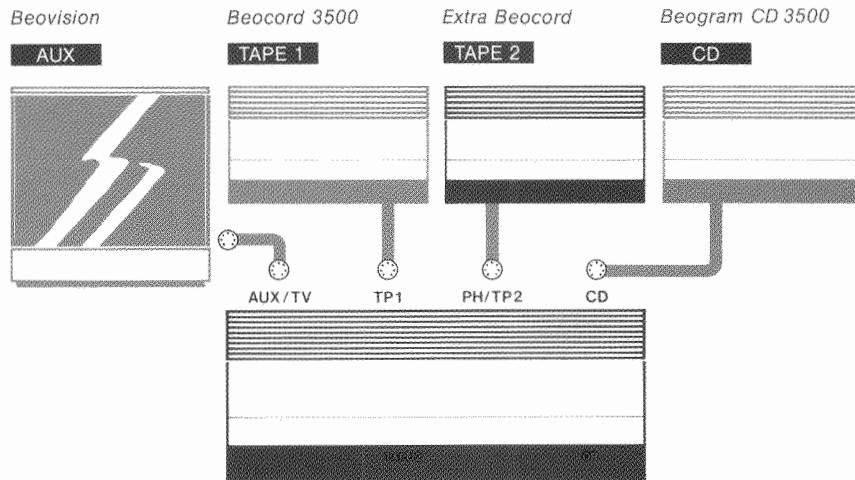
**CD OP**

In this set-up a second Beocord has been connected instead of a TV-set.

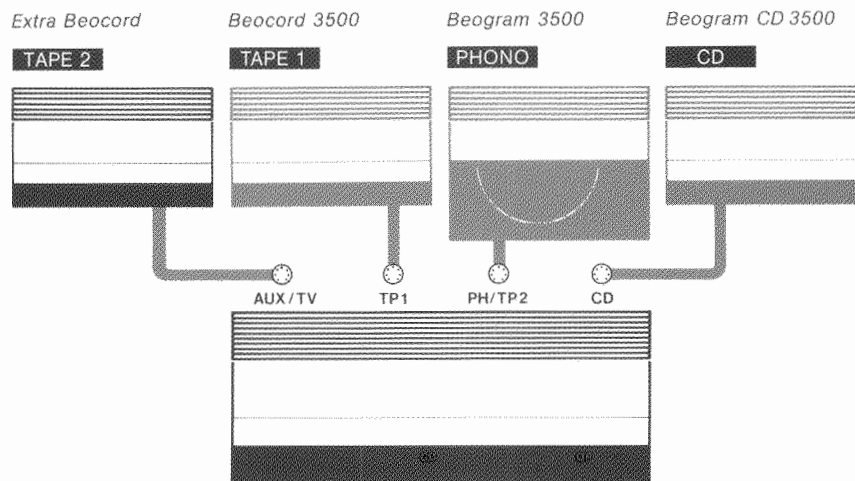

## PHONO OP

In this set-up a Beogram *without* a built-in RIAA pre-amplifier has been connected.

*Note!* In this case, the Beomaster 3500 must be fitted with a RIAA pre-amplifier (part no. 8002956). Contact your Bang & Olufsen dealer.

A second Beocord can be connected to the AUX/TV socket instead of a TV-set. In this case, press **TAPE 2** to turn on the tape recorder.

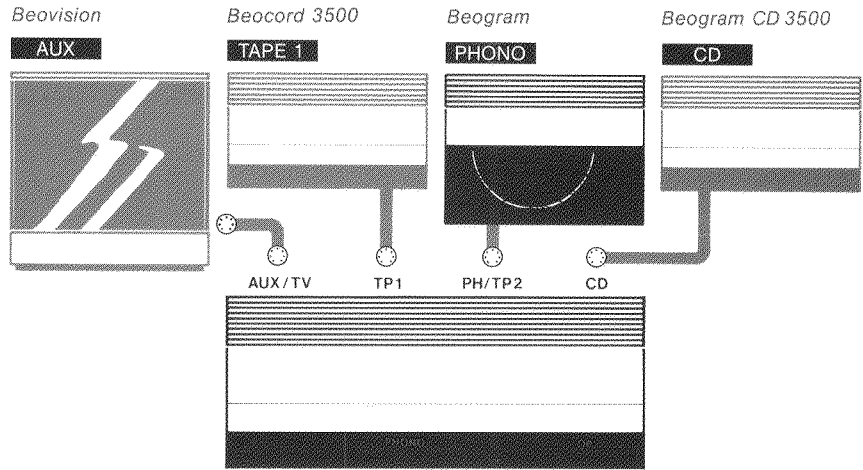

When leaving the factory, the Beomaster 3500 is set to the TAPE 2 option.

You can check/change the option setting in the following way:

1. Switch the Beomaster 3500 to stand-by.
2. Press **PROGRAMMING** and **7** simultaneously to reveal the current option.  
The display indicates OP, and depending on the option setting the cue TAPE 2, CD or PHONO lights up.
3. While the cues are still visible, press **TAPE 2**, **CD** or **PHONO** to select the option which suits your set-up situation.

## THE BEOCORD 3500

*This section explains how to operate the Beocord 3500. Before you start using the tape recorder, make*

*sure you have set it up according to the instructions in the section "Setting up".*

### Loading a cassette

The cassette compartment is under the hinged lid. To gain access to the cassette compartment, press **LOAD** on the operation panel. Place the cassette in the compartment with the tape slots facing you, and with side 1 (or A) pointing upwards.

Close the lid by pressing **LOAD** again. The lid may be left open during playback or recording. When the tape recorder is switched to stand-by, the lid closes automatically.

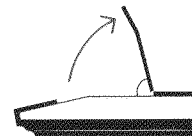

### Playing back a tape

Press **PLAY** to start playback.

The tape recorder automatically adjusts to the type of tape used: metal, chrome or ferric.

If the tape was recorded with the Dolby B noise reduction system (please see "Using Dolby NR"), set the DOLBY NR switch to ON.

During playback the signal level of the recording is indicated by the

lights in the VU-meter in the left-hand side of the operation panel.

If you have loaded a cassette which has not been rewound completely, you can start playback by pressing **START GO**. The tape will be rewound to the start of side 1, and playback will start immediately.

Playback continues until the tape runs out, or until you press **STOP** to stop playback. The tape will pause

until you press **PLAY** again. You can also stop playback by pressing **STOP** to switch to stand-by.



## Winding and rewinding

---

Press **[>>]** to wind the tape.

Press **[<<]** to rewind the tape.

Rewinding always means returning to the start of side 1, and winding always means moving to the end of side 2, unless you have cut out the automatic tape reverse function.

## Stepping through tracks

---

Press **[STEP>]** once to step forwards to the next track. Press **[STEP>]** the number of times required to step to the desired track further ahead.

Press **[<STEP]** to step backwards to the beginning of the track you are listening to. Press **[<STEP]** two or more times to step to preceding tracks.

If you want to play a track two or more steps ahead or behind, keep your finger on **[STEP>]** or **[<STEP]**. The **STEP>** or **<STEP** cue flashes once for each step the tape recorder will make.

The tape recorder will only be able to recognize the tracks on a tape if there is a pause of at least 2.5 seconds between them.

## Recording

If you want to use the Dolby B noise reduction system, set the DOLBY NR switch to ON.

1. Press **[REC]** once to switch to recording pause mode.  
The cues REC and STOP light up.
2. Start playing the source you want to record from, e.g. the Beogram 3500\*.
3. Adjust the recording level using the REC LEVEL slider.
4. Press **[REC]** a second time to start recording.  
The STOP cue disappears leaving just the REC cue lighting up.

5. Press **[STOP]** once to stop recording.

The STOP cue lights up again, and the REC cue flashes briefly. The tape recorder will insert a blank of 4 seconds on the tape before stopping.

6. Press **[STOP]** again to leave the recording mode.

If you do not want the 4 second pause on your tape, press **[STOP]** twice in rapid succession.

\* Subject to copyright law.

If you wish to change a recording which is already in progress, press **[<STEP]**. The tape will be rewound to the spot where **[REC]** was last pressed, and you can now resume recording, or you can press **[STOP]** to leave the recording mode.

If you are recording from the Beogram CD 3500 or the Beogram 3500, recording stops automatically when the compact disc or record is finished. Likewise, if the tape runs out during recording, the Beogram CD 3500 or the Beogram 3500 stops automatically.

## Using the auto reverse function

The Beocord 3500 features an automatic tape reverse function, which means that you do not have to turn the tape manually. The tape recorder automatically reverses the tape at the end of side 1 and continues playback or recording on side 2. The side of the cassette

which is facing you when loaded in the cassette compartment is regarded as side 1.

You can cut the automatic tape reverse function in or out as you please. Set the AUTO REV switch to ON to cut in the function, or set it to OFF to cut it out.

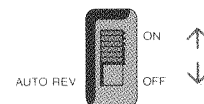

## Using Dolby NR

The Dolby B noise reduction system can be switched on and off before or during playback or recording. Set the DOLBY NR switch to ON to cut in the function, or set it to OFF to cut it out.

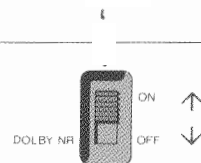

## Recording level

The REC LEVEL slider is used to adjust the signal level prior to or during a recording. The recording level is indicated in the VU-meter in the left-hand side of the operation panel. We recommend that you aim to keep the recording level around the red arrow in the VU-meter with only occasional blinks in the red area to the right of the arrow.

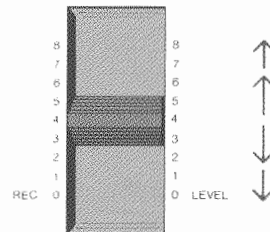

## THE BEOGRAM CD 3500

*This section explains how to operate the Beogram CD 3500. Before you start using the compact disc*

*player, make sure you have set it up according to the instructions in the section "Setting up".*

### Loading a compact disc

---

The disc compartment is under the hinged lid. To gain access to the disc compartment, press **[LOAD]** on the operation panel. Place the compact disc in the compartment with the printed side facing you.

The lid closes automatically when playing is started. When the CD-player is switched to stand-by, the lid also closes automatically.

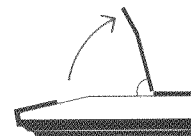

### Playing a compact disc

---



Press **[PLAY]** to start playing a compact disc. The CD-player registers all the tracks on the compact disc as indicated by the display on the operation panel. Track numbers above 14 are indicated by +.

As soon as all tracks are registered, playing starts at track 1.



Playing continues until the disc runs out, or until you press **[STOP]** to stop playing. The CD-player pauses until you press **[PLAY]** again. You can also stop playback by pressing **[●]** to switch to stand-by.

## Searching through a compact disc

---



You can search through a compact disc to find a specific point on the disc. Keep your finger on  to search forwards, or on  to search backwards through the tracks. Lift your finger to stop



searching. Playing starts immediately.



You can search at three speeds. If you keep your finger on  or , the speed will accelerate.

## Stepping through tracks

---

Press  once to step forwards to the next track. Press  the number of times required to step to the desired track further ahead.

Press  once to step backwards to the beginning of the track you are listening to. Press  two or more times to step to preceding tracks.

If you want to play a track two or more steps ahead or behind, keep your finger on  or . The STEP> or <STEP cue flashes once for each step the CD-player will make.

## Digital output

---

The digital output on the rear panel is intended for possible future digital equipment.



## THE BEOGRAM 3500

*This section explains how to operate the Beogram 3500. Before you start using the record player, make*

*sure you have set it up according to the instructions in the section "Setting up".*

### Adjusting stylus pressure

---

The stylus pressure must be adjusted to match the MMC cartridge fitted on the tonearm. Set the slider situated on the right-hand side of the tonearm to the appropriate value:

- MMC 1 = 1.0 gram
- MMC 2 = 1.0 gram
- MMC 3 = 1.2 grams
- MMC 4 = 1.2 grams
- MMC 5 = 1.5 grams

If you want to check the stylus pressure using a stylus gauge, place the gauge underneath the stylus and lower the tonearm onto the gauge by pressing  for more than 2 seconds. The pressure can now be read off from the gauge.

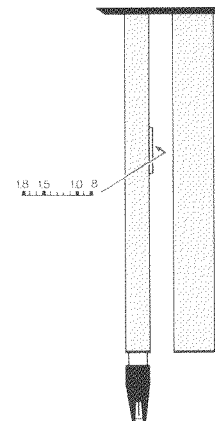

## Setting speed

---

The Beogram 3500 automatically registers the size of the record on the turntable and selects the appropriate speed, 33 or 45 rpm. The speed selected appears on the

indicator arm. The speed can also be selected manually, if required. Press **PLAY** and then **33** or **45**, as the case may be.



## Playing a record

---

If you want to clean the record before playing, press **←** to make the turntable rotate. The tonearm moves into position without lowering onto the record.



Press **PLAY** to start playing.

If there is no record on the turntable when you press **PLAY**, the turntable rotates briefly, and the tonearm remains in its resting position.

Playing continues until the record is finished, or until you press **●** to switch the record player to standby.

## Pausing

---





Press  or  to lift the tonearm off the record. The tonearm rises and remains in this position while the turntable continues rotating.

Press  when you want to resume playing.

If the record player is left in pause mode for more than 8 minutes, it will automatically switch to standby.

## Stepping through a record

---

You can move the tonearm to any position on a record and start playing from there. Use  to move the tonearm towards the centre of the record or use  to move the tonearm to the edge of the record. Keep your finger on  or  until you reach the desired spot. Then release the button and press  to start playing.

During this procedure a tiny beam of light illuminates the record to help you find the desired spot.



## Repeating a record

---

You can make the record player play a record up to seven times in a row. Press **PLAY** to start playing, then press **PLAY** again the number of times you want to have the record repeated. The speed indicator flashes indicating that the record will be repeated.

If you press **→**, **←** or **●**, the repeat command will be cancelled.

## REMOTE CONTROL

The Beolink 1000 is a versatile remote control unit. It allows you to operate all the units in your Beo-system 3500 from a distance.

### Primary functions

<i>Play radio</i>	Press <b>RADIO</b> .
<i>Select preset stations</i>	Press <b>0 - 9</b> or <b>&gt;</b> <b>&lt;</b> .
<i>Automatic tuning</i>	Press <b>GO TO</b> <b>&gt;</b> or <b>&lt;</b> .
<i>Raise volume</i>	Press <b>▲</b> .
<i>Lower volume</i>	Press <b>▼</b> .
<i>Reset sound</i>	Press <b>RESET</b> .
<i>Memorize sound levels</i>	Press <b>SOUND</b> <b>STORE</b> <b>STORE</b> .
<i>Mute the sound</i>	Press <b>MUTE</b> .
<i>Recall the sound</i>	Press <b>MUTE</b> again.

<i>Play tape</i>	Press <b>A.TAPE</b> .
<i>Stop playing</i>	Press <b>STOP</b> .
<i>Resume playing</i>	Press <b>PLAY</b> .
<i>Wind or rewind tape</i>	Press <b>&gt;&gt;</b> or <b>&lt;&lt;</b> .
<i>Select track number</i>	Press <b>0 - 9</b> or <b>&gt;</b> <b>&lt;</b> .

*Play compact disc* Press [CD].

*Stop playing* Press [STOP].

*Resume playing* Press [PLAY].

*Search through compact disc* Press [>>] or [<<].

*Stop searching* Press [STOP] or [PLAY].

*Select track number* Press [0] - [9] or [>] [<].

*Play record* Press [PHONO].

*Stop playing* Press [STOP].

*Resume playing* Press [PLAY].

*Step through record  
(in 8 mm increments)* Press [>] or [<].

*Switch off audio system* Press [●].

*Switch off Beolink system* Press [SHIFT] [●].

## THE BEOMASTER 3500 IN A BEOLINK SYSTEM

*The Beomaster 3500 can be used as a full-fledged member of a Bang & Olufsen Beolink system. In a Beolink system, audio and video products are interconnected and they can all be operated using the Beolink 1000 terminal.*

If your Beomaster 3500 is part of a Beolink system, you obtain a number of facilities called Beolink

functions. Among other things these facilities enable you to listen to the radio through the TV speakers or to hear a TV program through the audio speakers.

Connect the Beolink compatible TV-set to the AUX/TV socket on the rear panel of the Beomaster 3500 using a 7-pin DIN cable (see "Optional accessories").

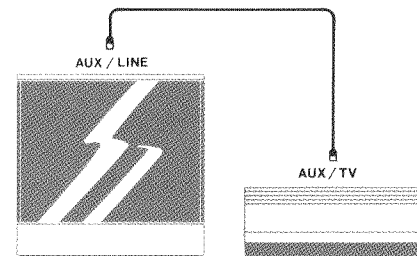

The Beolink system may be set up in two different ways to suit individual usage patterns.

When the Beolink system has been set up, both the Beomaster and the Beovision must be programmed according to the chosen set-up. Use the Beolink 1000 to pre-program the Beomaster 3500, which *must be in stand-by mode during pre-programming.*

To select the option which suits your set-up situation, press **[SOUND]**, the appropriate option number (1-2), and **[STORE]**.

The chosen option number will

### Option 1, Situation 1

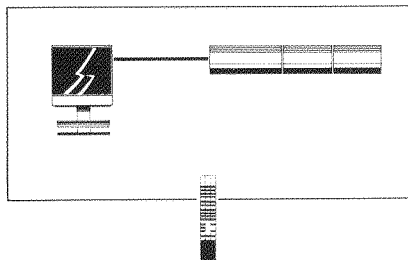

The audio and video systems are placed so close to each other that the commands from the Beolink 1000 can be received by both systems at a time.

### Option 2, Situation 2

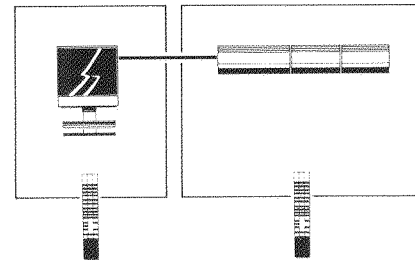

The audio and video systems are placed far apart, e.g. in separate rooms, so that the commands from the Beolink 1000 can be received by only one system at a time.

appear in the display as a confirmation that the commands have been received.

When leaving the factory, the Beomaster 3500 is set to option 1.

## How to obtain the Beolink functions

---

If your Beolink system is set up according to *situation 2*, you can operate the audio or video system as usual to obtain the Beolink functions.

If, however, your Beolink system is set up according to *situation 1*, you must use the **AV** button on the Beolink 1000 to obtain the Beolink functions. The **AV** button relays the commands following the **AV** command from one system to the other.

For example, if you press **AV** and then **CD**, the compact disc player will start playing, but the music will be reproduced by the TV speakers. If you press **AV** and then **TV** you will hear the TV program in the audio speakers.

## OPTIONAL ACCESSORIES

*The accessories referred to in this section are all available as optional extras from your Bang & Olufsen dealer.*

### Wall bracket

---

The WB 4500 wall bracket, type no. 2030, enables you to hang the Beomaster 3500, the Beocord 3500 and the Beogram CD 3500 on the wall. One wall bracket is required for each of these products.

Add the shelf, type no. 2012, for the Beogram 3500, and you can hang the entire Beosystem 3500 on your wall.

### Headphones

---

The Bang & Olufsen Form 1 or Form 2 stereo headphones can be connected to the Beomaster 3500 through the headphones socket on the front. If you plug in headphones, the loudspeakers connected to the upper pair of speaker sockets (1 L/R) or to the POWER LINK sockets are cut out.

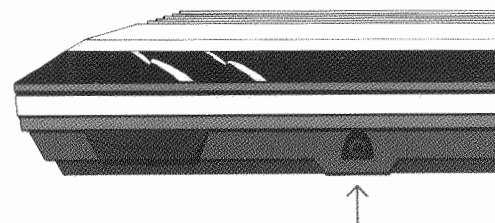

## Indoor antennae

If FM reception is good in your area, you may rely on the indoor FM antenna, part no. 8902010, to pick up the stations available. Attach it to the Beomaster 3500 using an antenna bracket, part no. 3152006.

The active AM antenna AA10, part no. 8920376, can be used for reception of distant AM stations. It is designed for connection to the mains and is fitted with mains plug and indicator.

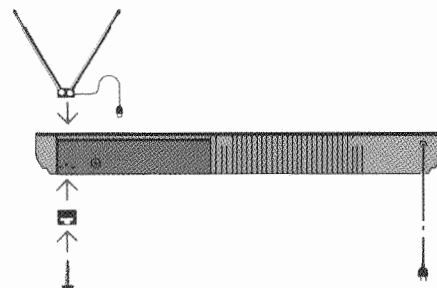

## Beolink cable

A Beolink cable with 7-pin DIN plugs (Datalink) is required to connect your audio and video systems to form a Beolink system. The Beolink cable is available in different lengths:

*Part no.*  
6270222, black, 1.5 m  
6270353, black, 5 m  
6270337, black, 10 m  
6270354, black, 20 m  
6270338 (extension cable) 1.5 m

*Part no.*  
6270393, grey, 1.5 m  
6270394, grey, 5 m  
6270395, grey, 10 m  
6270396, grey, 20 m

## Master Control Link 2

The MCL 2 system enables you to listen to music in any room in your house in which you have installed an MCL 2 A or 2 AV and a pair of loudspeakers or a TV-set. The MCL 2 system must be connected to the lower pair of speaker sockets

(2 L/R) on the Beomaster 3500. You can operate all the functions in the Master Control Link 2 system using the Beolink 1000.

Ask your dealer for further details about the MCL 2 system.

# MAINTENANCE

## Surfaces

---

Use a dry cloth to wipe dust off each unit of the Beosystem 3500. Remove fingerprints and grease stains using a soft cloth moistened with a little diluted mild detergent. Wring the cloth firmly before use.

*Never use denatured alcohol to clean any parts of the Beosystem 3500.*

## Tape deck

---

The tape path, i.e. tape heads, pinch rollers and other parts which the tape touches during play or recording, should be cleaned every now and then to prevent dust and fluff building up on them.

Use a tape head maintenance kit, or a cotton swap dipped in a special fluid designed for this purpose. The cleaning process must be carried out with no cassette in the compartment.

Cleaning the tape head and pinch rollers is easier when they are in an exposed position. Press **[PLAY]** to expose the tape head and the left-hand pinch roller and clean them as prescribed. Press **[PLAY]** again to expose and clean the right-hand pinch roller. During this process the pinch rollers will be turning. Press **[STOP]** to finish the cleaning process.

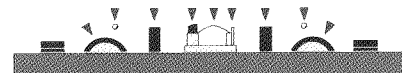



# Stylus

---

Fluff and dust can build up on the tip of the stylus and cause distortion during play. Therefore, clean the stylus every now and then using the tiny brush provided.

Carefully brush the stylus from the back of the cartridge towards the front. Any stylus cleaning fluid should be used in moderate amounts.

Reducing the amount of dirt and dust on the record to a minimum is of course the best way to keep the stylus clean and thus to ensure optimum performance. For this purpose we recommend you use the Bang & Olufsen LP Protector record maintenance kit. The Bang & Olufsen LP Protector is available from your Bang & Olufsen dealer.

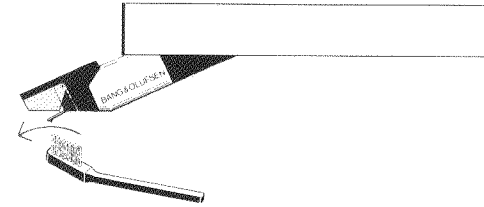

# TECHNICAL SPECIFICATIONS

<b>Beomaster 3500</b>	<b>Type no. 2966/2967/2969/2970</b>
Long-term max. output power IEC	2 x 55 watts/8 ohms
Power output 20-20,000 Hz IHF	2 x 20 watts/8 ohms
Total harmonic distortion IHF	<0.1% at 20 watts 20-20,000 Hz
Dynamic headroom	1.6 dB/8 ohms
Intermodulation IHF	<0.1%
Response vs frequency:	
Phono - tape	20-20,000 Hz $\pm$ 1.5 dB
Wideband damping factor	32
Input sensitivity/impedance:	
Tape1 - Phono/Tape2 - AUX - CD	30 mV/100 kohms
Signal-to-noise ratio:	
Phono A-weighted	>75 dB
Tape - CD A-weighted	>77 dB
Output:	
Tape	500 mV/470 ohms
Headphones	Max. 15 volts/220 ohms
FM range	87.5 - 108 MHz
FM aerial impedance	75 ohms
Usable sensitivity stereo	19 dBf-2.5 $\mu$ V/75 ohms
50 dB quieting sensitivity stereo	40 dBf-28 $\mu$ V/75 ohms
Signal-to-noise ratio 65 dBf stereo	70 dB
Frequency response	20-15,000 Hz $\pm$ 1 dB
Distortion at 65 dBf stereo	0.3%
Intermodulation stereo	0.1%
Stereo channel separation	40 dB
AM tuner section:	
LW range	150-350 kHz
MW range	520-1610 kHz
LW sensitivity 20 dB S/N ratio	80 $\mu$ V
MW sensitivity 20 dB S/N ratio	60 $\mu$ V
Power supply	2966: 220 volts 2967/2970: 240 volts 2969: 100 volts
Power frequency	50-60 Hz
Power consumption	10-135 watts
Dimensions W x H x D	62 x 7 x 24.5 cm
Weight	7 kg

<b>Beocord 3500</b>	<b>Type no. 4966/4967/4969/4970</b>
Compact cassette	C46-C60-C90-C120
Recording system	HX PRO
Tape head	Sendust
Wow and flutter WRMS	<0.09%
Frequency range chrome	30-18,000 Hz $\pm$ 3 dB
Signal-to-noise ratio CCIR/ARM:	
Metal Dolby B NR	>64 dB
Chrome Dolby B NR	>63 dB
Ferro Dolby B NR	>62 dB
Radio input, Line	100 mV/22 kohms
Radio output	660 mV/200 ohms
Power supply	4966: 220 volts 4967/4970: 240 volts 4969: 100 volts
Power frequency	50-60 Hz
Power consumption	18 watts
Dimensions W x H x D	42 x 7 x 24.5 cm
Weight	4.5 kg

<b>Beogram CD 3500</b>	<b>Type no. 5146/5147/5149/5150</b>
Frequency range	3-20,000 Hz $\pm$ 0.3 dB
Signal-to-noise ratio	>100 dB/110 dB A-weighted
Harmonic distortion	<0.0025% at 0 dB <0.025% at -20 dB
Channel difference	<0.08 dB
Converter system	2 x 16 bit, 4 x oversampling 176.4 kHz
Low-pass filter	Digital + Bessel/elliptical analog
Phase error between L and R	0 degree at 20-20,000 Hz
Output, analog	1.3 volts RMS at 0 dB
Output, digital	For digital equipment
Power supply	5146: 220 volts 5147/5150: 240 volts 5149: 100 volts
Power frequency	50-60 Hz
Power consumption	23 watts
Dimensions W x H x D	42 x 7 x 24.5 cm
Weight	4.5 kg

<b>Beogram 3500</b>	<b>Type no. 5976/5978/5979</b>
Tonearm	Tangential Optimum Pivot Point
Motor	Servo controlled DC
Wow and flutter, WRMS	<0.03%
Rumble DIN weighted	>80 dB
Speeds	33-45 rpm.
Speed deviation	< $\pm 0,2\%$
Power supply	5976/5979: 190-265 volts
	5978: 90-130 volts
Power frequency	50-60 Hz
Power consumption	<10 watts
Dimensions W x H x D	42 x 7.5 x 32.5 cm
Weight	5.3 kg
<b>Pick-up preamplifier RIAA</b>	Built-in, optimized for MMC
Frequency range	20-20,000 Hz $\pm 1$ dB
Signal-to-noise A-weighted	>80 dB
Distortion 1000 Hz	<0.02%
Output 1000 Hz, 20 cm/sec.	1 volt
Output impedance	<2 kohms

#### **Subject to change without notice**

The Beocord 3500, the Beogram 3500 and the Beogram CD 3500 fulfil the conditions stated in the EEC Directive 82/499 concerning radio frequency interference.

# INTERNATIONAL GUARANTEE

This Bang & Olufsen product carries a guarantee against defects in workmanship and materials. It is a national guarantee, extended by Bang & Olufsen to the country in which the product was bought. The terms of the guarantee apply principally to the country of purchase but will be met by authorized Bang & Olufsen dealers in other countries. The guarantee period applying to the country of purchase takes priority over guarantee periods applying in other countries, even where differences exist.

In order to obtain service under this guarantee, a certificate stating the following information is required:

- Name of product and type number
- Serial number
- Date of purchase
- Guarantee period
- Dealer's or supplier's signature

Bang & Olufsen  
DK-7600 Struer  
DENMARK





3502690

8049